

pecron

# E3800 LFP

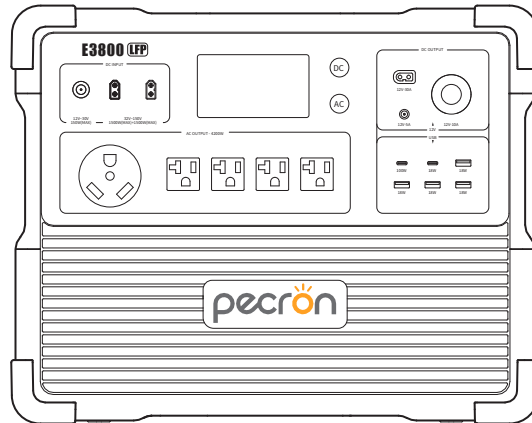

## USER MANUAL

Please read the user manual thoroughly before using

support@pecron.com

# FUNCTION INTRODUCTION

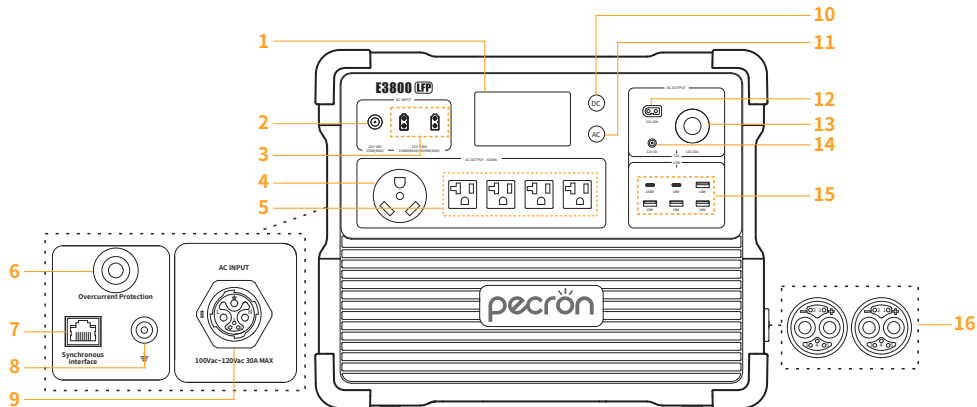

1 LCD Display

2 DC 12V~30V Charging Port

3 DC 32V~150V Charging Port

4 AC TT30-R Output

5 AC 100V~120V Output

6 Overcurrent Protection

7 RJ45 Signal Sync Interface

8 External Grounding Port

9 AC 100V~120V Input

10 DC 12V/USB Switch

11 AC 100V~120V Switch

12 DC12V XT60 Output

13 DC12V Auxiliary Output





14 DC12V(5525)Output

15 USB-A/USB-C Ports



16 Battery Expansion Port

# SPECIFICATIONS

## GENERAL INFO

 Capacity	3840Wh(51.2V75Ah)	 Temperature	0°C~45°C/32°F~113°F (Charging) -20°C~45°C/-4°F~113°F (Discharging) -20°C~45°C/-4°F~113°F (Storage) Optimal storage temperature: 20°C ~ 30°C / 68°F ~ 86°F
 Battery Type	LiFePO4 (3500+Cycles to 80%)		
 Net Weight	Around 87.3lb Around 39.6Kg	 Dimension	L17.5*W12.1*H14.7 in L445*W307*H373 mm

## DC OUTPUT

 USB-A *4	(5V,9V,12V,Max 18W)*4	360W Max
 USB-C *2	(5V,9V,12V,Max 18W)*1 (5V,9V,12V,20V,Max 100W)*1	
 XT60-F Output *1	DC 12V-30A	
 Cigar Port *1	DC 12V-10A	
 DC 5525 Output *1	DC 12V-5A	

## AC OUTPUT

 BS-U20 *4	Pure sine wave 100V~120V Rated 4200W Max
 TT30-R *1	

## AC INPUT



MJ25 (3+2) \*1

100Vac~120Vac 50/60HZ  
3200W Max (Charging cable with 30A)

## DC INPUT



5521 \*1

12V~30V Max 7A Max 150W

3150W Max



XT60-M \*2

32V~150V Max 20A Max 3000W (1500W+1500W)

## EXTRA BATTERY PORT





MJ32 \*2

Cascade with max 6 pieces of EP3800-48V

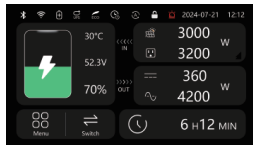
## HOW TO USE THE E3800 LFP



 press and hold to turn on / off DC / USB

 press and hold to turn on / off AC

(Please turn off the AC function if there is no AC load on the unit)

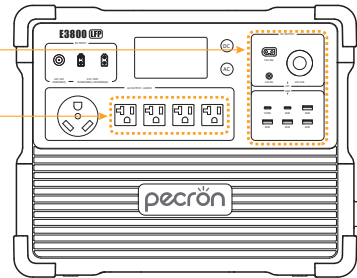

# DETAILS AND OPERATING INSTRUCTIONS OF THE DISPLAY

## Display and switch of home page 1

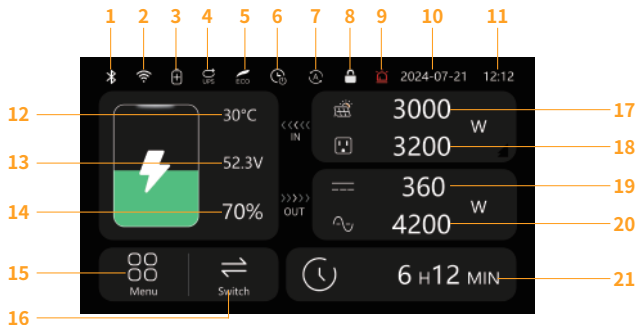

1 Bluetooth connection

2 WIFI connection

3 Connection of expansion battery pack

4 UPS ON

5 ECO ON

6 TIMER SWITCH ON

7 Automation has been set up

8 Touchscreen Lock

9 Warning

10 Date

11 Time

12 Battery Temperature

13 Battery Voltage

14 Battery Volume Percentage

15 Menu

16 Switch Button

17 DC Input

18 AC Input

19 DC Output

20 AC Output

21 Remaining Discharge Time /Remaining Charge Time

## Display and switch of home page 2

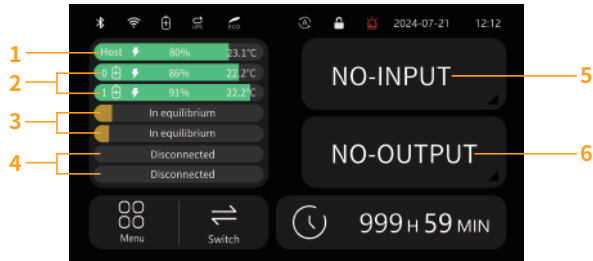

1 Main Unit Remaining Capacity

3 Battery Balancing Status

5 Input Status

2 Extension Pack Remaining Capacity

4 Extension Pack Disconnected

6 Output Status

## HOW TO SET THE TIME AND LANGUAGE OF THE SCREEN ?

Click "Menu" showed as **(Picture 1)**.

Then click "System Setting" showed as **(Picture 2)**.



**(Picture 1)**

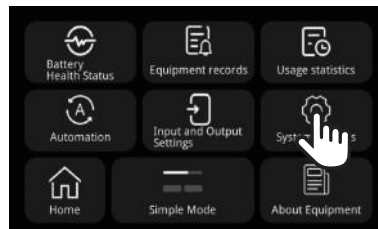

**(Picture 2)**

1: Page up/down by clicking " $\wedge$ " / " $\vee$ " on the left side.

2: Click "Time setting" to adjust the time showed as **(Picture 3)**.

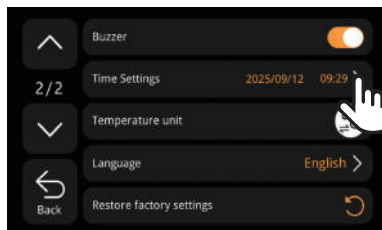

**(Picture 3)**



3: Click "Language" to adjust language type. Showed as **(Picture 4)**.

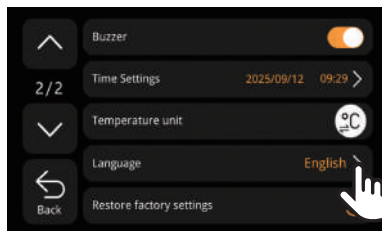

**(Picture 4)**

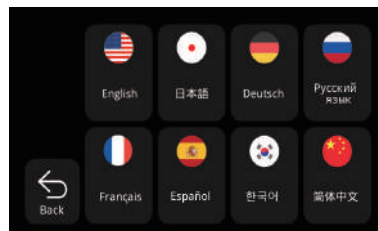

## HOW TO CONNECT WITH APP ?

Click "Menu" showed as **(Picture 1)**.

Then click "System Setting" showed as **(Picture 2)**.



(Picture 1)

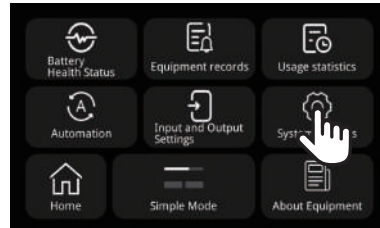

(Picture 2)

1: Click "WIFI reset" showed as **(Picture 3)**.

2: Click "✓" to reset the WIFI and enter the pairing mode showed as **(Picture 4)**.

And then search the device model through the near field on the APP.

If you connect to the APP via WIFI successfully, the WIFI symbol will be displayed.

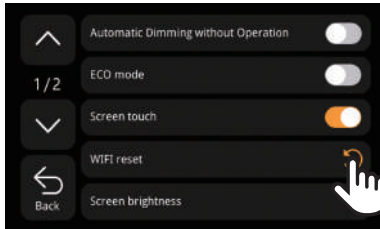

(Picture 3)

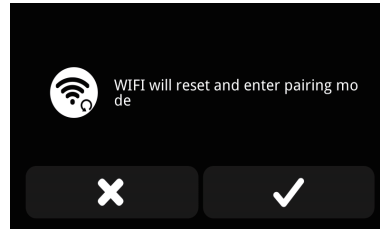

(Picture 4)

## HOW TO OPERATE THE SETTING OF INPUT AND OUTPUT ?

Click "Menu" showed as **(Picture 1)**.

Then click "Input Output Settings" showed as **(Picture 2)**.



**(Picture 1)**

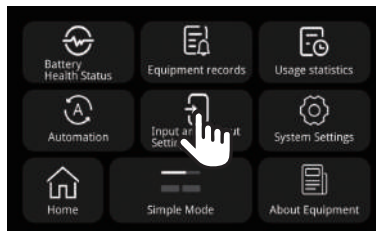

**(Picture 2)**

Click each option to make the corresponding settings showed as **(Picture 3)**.

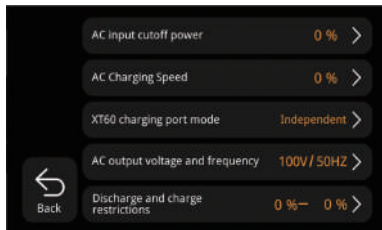

**(Picture 3)**

# STATISTICS FEATURE OVERVIEW

Click "Menu" showed as **(Picture 1)**.

Then click "Usage statistics" showed as **(Picture 2)**.



**(Picture 1)**

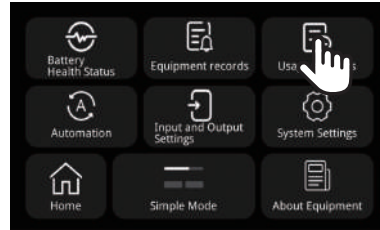

**(Picture 2)**

To view statistical data, click the ">" menu and select the corresponding statistics.

In the Power Statistics section, you can click the toolbar below to select the power curve display **(Picture 3)**, or use the buttons on the right to zoom in/out on the X-axis.

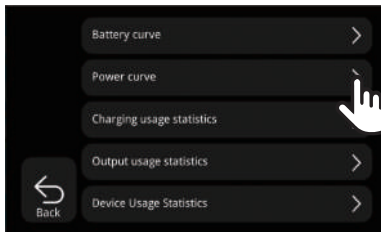

**(Picture 3)**

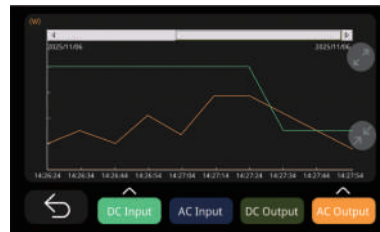

**Note: Curve data is not retained after power-off and will be cleared upon device shutdown.  
Recording duration is limited to the last 48 hours.**

In the Input/Output Energy Statistics (**Picture 4/5**), you can toggle between Day/Month/Year via the toolbar below. Day shows the last 24 hours, Month the last 31 days, and Year the last 12 months. You can also click the progress bars in the table to view corresponding data.

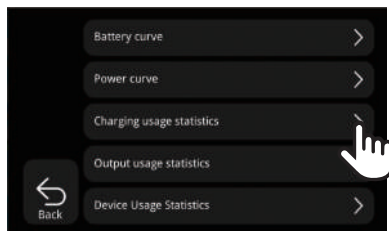

(Picture 4)

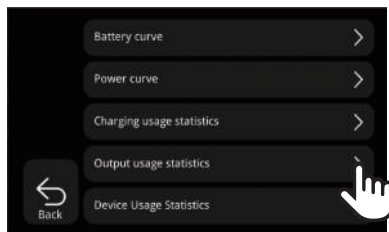

(Picture 5)



In the Device Usage Statistics, you can set the electricity cost and toggle the unit by clicking the cost button (Picture 6).  
Savings = Electricity cost × (DC/PV Input Energy). You can also view the estimated CO2 reduction, calculated as 0.8 kg saved per 1 kWh generated.

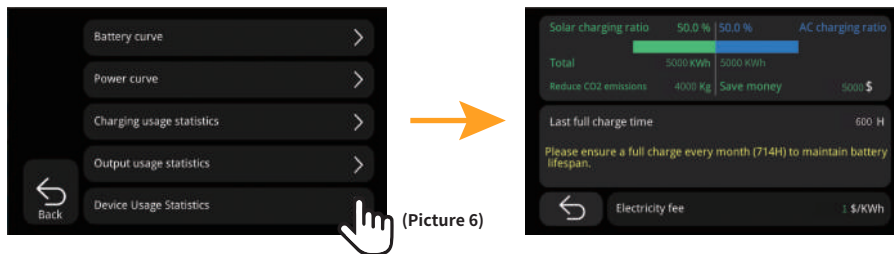

**Note: This device is not a professional instrument.  
Statistical data may have minor deviations and is for reference only.**

# AUTOMATION FEATURE OVERVIEW

Click "Menu" showed as **(Picture 1)**.

Then click "Automation" showed as **(Picture 2)**.



**(Picture 1)**

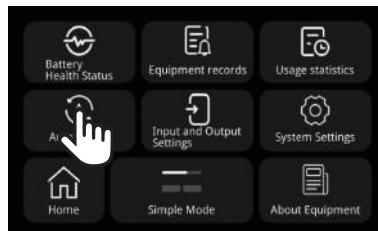

**(Picture 2)**

Click "+" to create up to 4 automation rules **(Picture 3)**. You can configure conditions and actions. Actions will execute automatically when conditions are met. Use "↶" to reset, "✓" to save and exit **(Picture 4)**, and "?" for automation instructions. **(Picture 5)**.

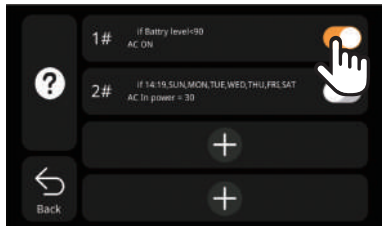

**(Picture 3)**

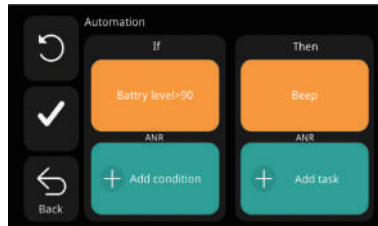

**(Picture 4)**

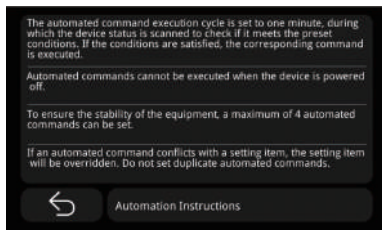

**(Picture 5)**

# EVENT LOG FEATURE OVERVIEW

Click "Menu" showed as **(Picture 1)**.

Then click "Equipment records" showed as **(Picture 2)**.



(Picture 1)

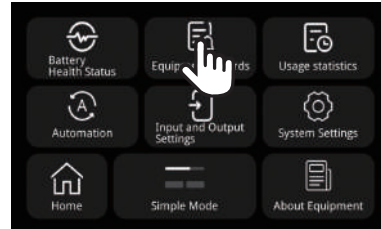

(Picture 2)

The device automatically logs: DC/AC input/output ON/OFF events, UPS status, ECO mode, Display Touch Lock, Host Battery at 100% or 1%, DC output >360W, and AC output >4200W **(Picture 3)**.



(Picture 3)

**Note: The logging capacity is limited to 1,000 entries. Older entries will be overwritten when the limit is reached.**

# PACKING LIST

## Standard Product List

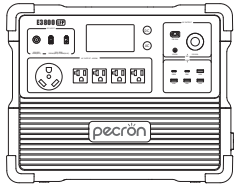

PECRON E3800 LFP \*1



15A AC Cable \*1

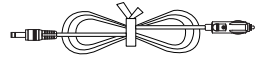

Car Charging Cable \*1



Single port XT60 to  
MC4 solar charging cable \*1



Parallel dual port XT60 to  
MC4 solar charging cable \*1



Slotted Screwdriver \*1



Accessory Pouch \*1

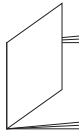

User Instruction \*1



Quick Start Guide \*1

## Optional product accessory

(\* The following accessories are not included in the standard package and can be purchased separately from PECRON)

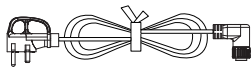

30A AC cable \*1

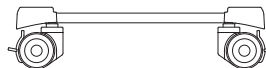

TE-200 Cart \*1

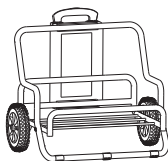

T2 Trolley



EP3800-48V

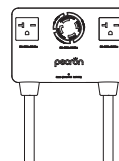

Completed set for  
series connection to 240V

## UPS FUNCTION

The E3800 LFP supports UPS function. It can provide the loads (such as computers, data centers, telecommunication equipment) near-instantaneous (within 8~20ms) protection from unexpected power interruptions of the main power supply.

**Note: Not applicable to specific applications that need transfer time under 8ms, such as servers and workstations. This**

**UPS function only support protection for loads under 1800W(15A AC Cable)/3600W(30A AC Cable), we recommend that you only connect one device at a time to avoid overload and thus result in protection failure.**

PECRON is not responsible for any devices damage or loss of data resulting from failing to follow the instructions.

When fully charged, the UPS will halt AC power draw. AC input will resume only when the battery level drops below 90%. (this function helps delay battery lifespan degradation.)

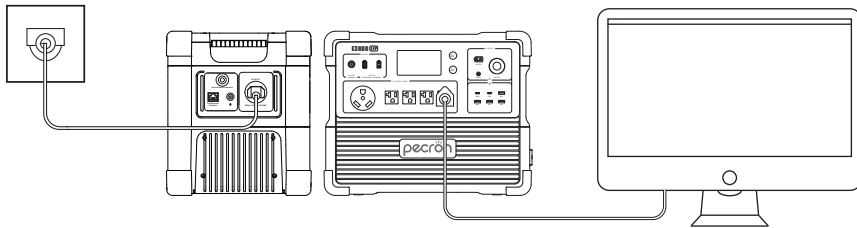

## EXPANDABLE BATTERY

Please use the official cascading cable with MJ32 socket when you want to connect with 6 pcs of expansion battery pack (EP3800-48V) to avoid damage of the power station.

### Notes about cascade:

- 1: Cascading will be faster if there is only 10% difference between the main power station and the expansion battery pack.
- 2: Before cascading, please make sure the number of knob on the battery pack is unique.

The number should be adjusted to 0,1,2,3,4,5 according to the number of packs.

If the number is wrong, the parameters of the packs will not be shown on the display of the main power station.

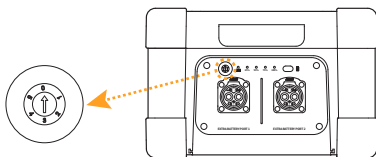

EP3800-48V

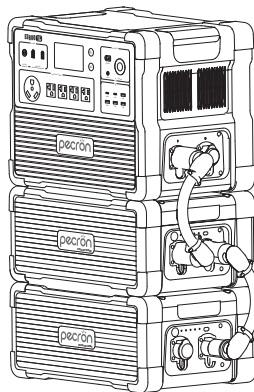

## HOW TO CHARGE THE E3800 LFP BY AC ?

A 15A cable will come together with the power station as standard accessories.  
The type of the cable will be automatically detected by the power station.

When you charge the power station with a 15A cable.

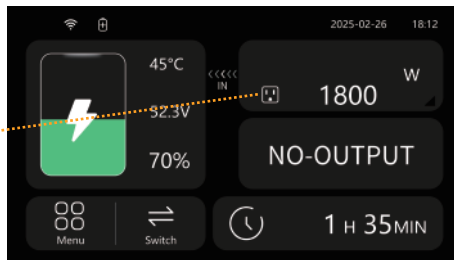
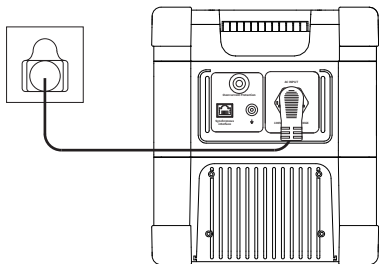

When you charge the power station with a 30A cable.

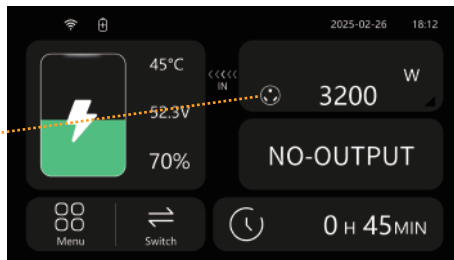
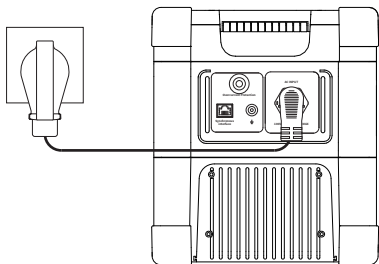

## HOW TO CHARGE THE E3800 LFP BY VEHICLE ?

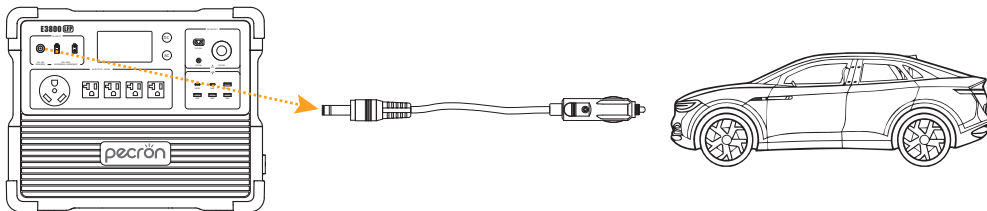

## USING SOLAR PANELS TO CHARGE THE E3800 LFP

- DC5521 Charging Port:** PV/DC 12V~30V, 150W maximum; VOC(open circuit voltage) of solar panel must be less than 30V;
- XT60-M Charging Port:** PV(operating voltage) range 32V~150V, 3000W maximum; VOC(open circuit voltage) of solar panel/array must be less than 150V, otherwise, it will damage the unit! **Do not wire more than three 36V solar panels in series, or more than six 18V solar panels in series.** (18V/36V stands for Vmp of the solar panel)
- If you have any questions, feel free to contact us: [support@pecron.com](mailto:support@pecron.com)**

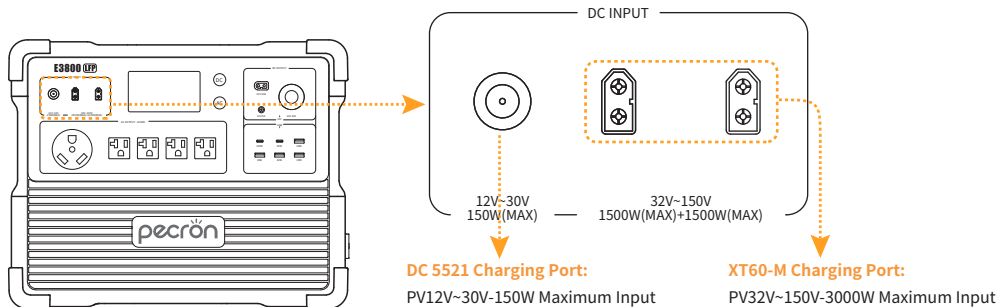

# USING SOLAR PANELS TO CHARGE THE E3800 LFP

## Charging the E3800 LFP with one solar panel

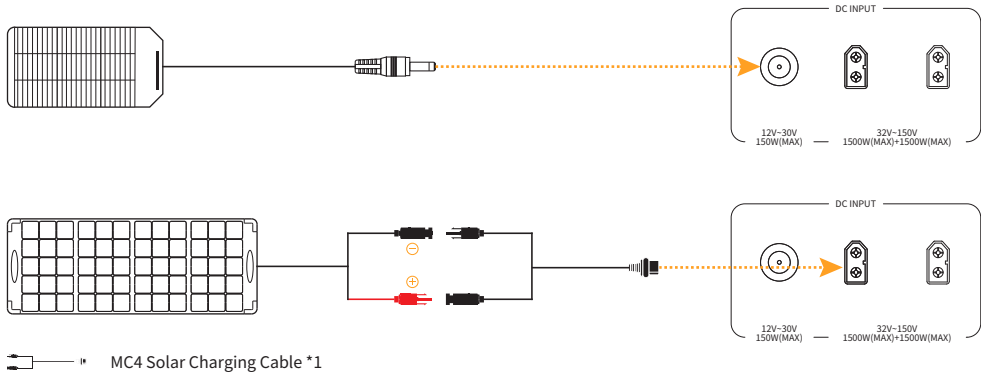

※ It is recommended to choose PECRON solar panels for optimal user experience! The VOC of a single solar panel should be less than 150V, and the VMP should be greater than 32V.

## Use two solar panels in series to charge the E3800 LFP

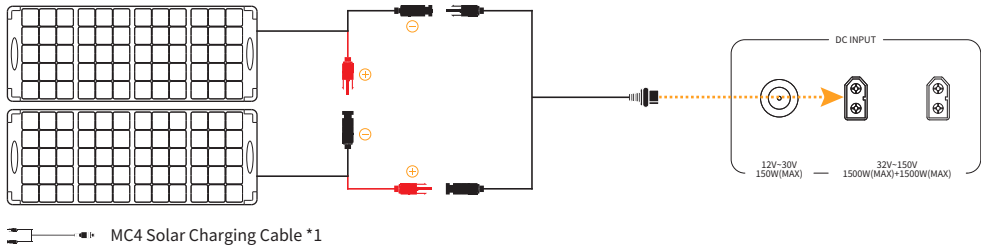

※ It is recommended to choose PECRON solar panels for optimal user experience! The VOC of a single solar panel should be less than 75V, and the VMP should be greater than 16V.

**Use three solar panels in series to charge the E3800 LFP  
(It is recommended to use solar panels with same specifications for optimal power.)**

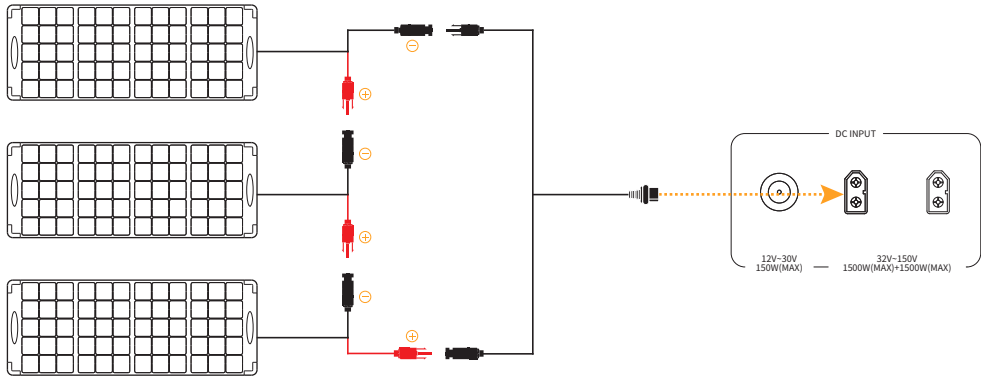

MC4 Solar Charging Cable \*1

※ It is recommended to choose PECRON solar panels for optimal user experience! The VOC of a single solar panel should be less than 50V, and the VMP should be greater than 11V.

**Use four solar panels in parallel to charge the E3800 LFP  
(It is recommended to use solar panels with same specifications for optimal power.)**

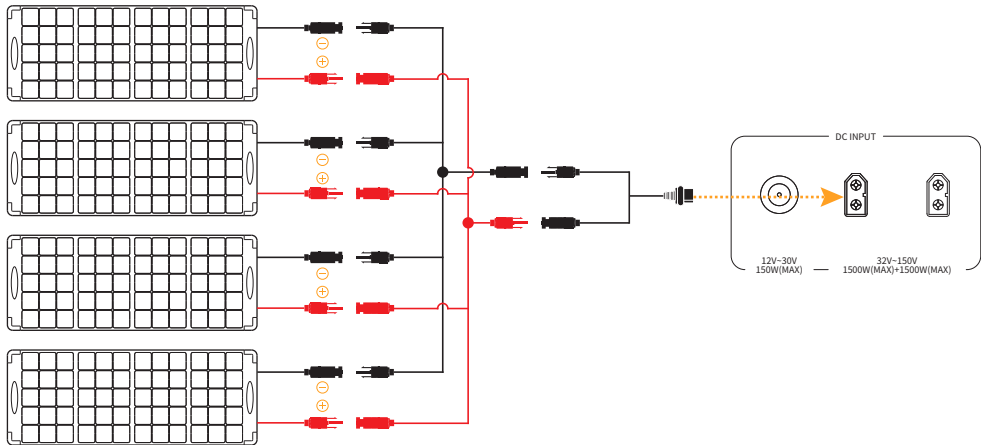

MC4 Solar Charging Cable \*1

Y Branch MC4 Charging Cable(+)\*1

Y Branch MC4 Charging Cable(-)\*1

(NOTE: This parallel charging cable sold separately)

※ It is recommended to choose PECRON solar panels for optimal user experience! The VOC of a single solar panel should be less than 150V, and the VMP should be greater than 32V.

## DO NOT WIRE FOUR SOLAR PANELS IN SERIES!

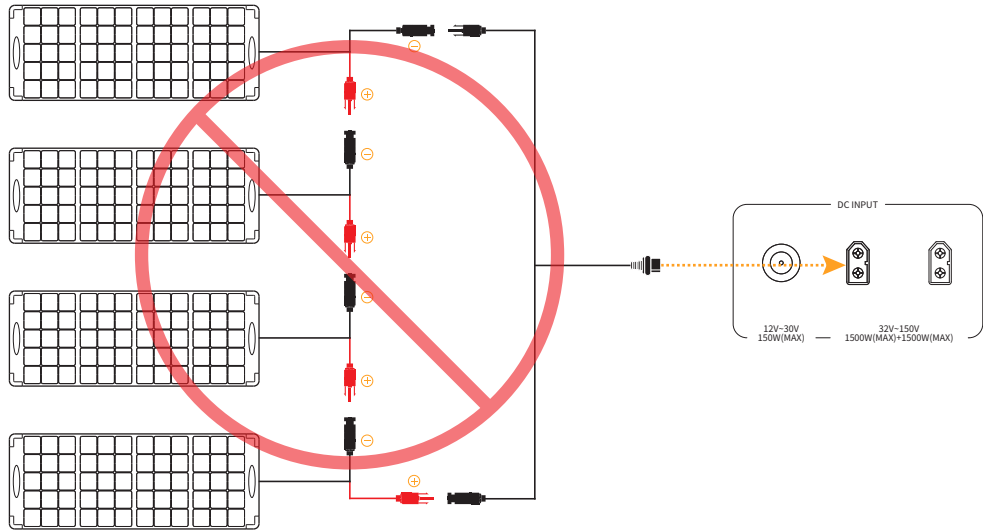

※ PV(XT60) Port Only work within 32V~150V Open Circuit voltage, exceeding 150V will damage the machine.

## COMMON ALARMS & SOLUTIONS

	FAULT TYPE	HANDLING SUGGESTION
1	Battery Pack Low Temperature	Battery temperature is too low. Please wait until the temperature rises above 0°C. It will automatically recover when the temperature increases.
2	Battery Pack High Temperature	Battery temperature is too high. Please wait until the temperature drops below 50°C. It will automatically recover when the temperature decreases.
3	Battery Pack Overvoltage	Please temporarily suspend charging or discharging. Check the load or charging equipment, and retry if no abnormalities are found.
4	Battery Pack Undervoltage	Please temporarily suspend charging or discharging. Check the load or charging equipment, and retry if no abnormalities are found.
5	Battery Pack Short Circuit	Please check if the cascade connection port (equipment connection port) is short-circuited.
6	Battery Pack Charging Overcurrent	Please suspend charging. If caused by overload or temperature rise, reduce the load and retry.
7	Battery Pack Discharging Overcurrent	Please suspend discharging. If caused by overload or temperature rise, reduce the load and retry.
8	Charging Board Input Overcurrent	Please stop DC charging. Check the specifications and ratings of the connected equipment.
9	Charging Board Input Overvoltage	Please stop DC charging. Check the specifications and ratings of the connected equipment.
10	Charging Board Output Overcurrent	Please stop DC output. Check the specifications and ratings of the connected equipment.
11	Charging Board Output Short Circuit	Please stop DC output. Check the specifications and ratings of the connected equipment.
12	Charging Board Input Undervoltage	DC input voltage is insufficient. Please increase the input voltage to the specified range and retry.
13	Charging Board Overtemperature	Please temporarily suspend DC charging. Check if the charging equipment or cables are abnormal.

FAULT TYPE		HANDLING SUGGESTION
14	DC Output Short Circuit	Please check if the external wiring on the DC output side is short-circuited. If the error reappears immediately after turning on the output, there may be an internal fault. Please contact PECRON.
15	DC Output Overvoltage	Please stop output. Confirm whether the connected load is appropriate. If the shutdown persists, please contact PECRON.
16	DC Output Overcurrent	Please stop output. Confirm whether the connected load is appropriate. If the shutdown persists, please contact PECRON.
17	DC Output Overtemperature	Please stop output. Confirm whether the connected load is appropriate. If the shutdown persists, please contact PECRON.
18	Mains Voltage Abnormality	This may be due to inverter failure or abnormal AC charging voltage. Please stop using and contact PECRON.
19	Mains Frequency Abnormality	Output frequency is abnormal. This may be due to inverter failure. Please stop using and contact PECRON.
20	Mains Input Overload	Please stop charging. Retry charging after the abnormality is resolved.
21	Inverter Output Overload	Output has stopped. This load cannot be used. Please confirm the load rating.
22	Inverter Output Short Circuit	Please check if the output socket is short-circuited. If abnormalities are found, please stop using.
23	Inverter Overtemperature	Output has stopped. Please place the device in a cool, dry location and allow sufficient heat dissipation.
24	Fan Failure	An abnormality in the cooling fan has been detected. Please stop using, replace the fan, or contact PECRON.

## FAQS

**Q1: What kind of battery is used in E3800 LFP? How long it can last?**

A: E3800 LFP utilizes high quality UL certified automotive LiFePO4 battery, it can retain 80% of its original capacity at 3500 complete charge cycles.

**Q2: What devices can E3800 LFP power?**

A: Please note that the AC output port can only charge or power devices that operate at less than 4200W.  
DC output port can only charge or power that operate at less than 12V-30A.

**Q3: Can the E3800 LFP be used as UPS?**

A: E3800 LFP supports UPS function with an automatic switchover time of 8~20ms.

**Q4: Can the E3800 LFP be charged while discharging?**

A: Yes, E3800 LFP can run devices while it is being charged. The battery will eventually run out if the discharging is greater than the charging during the pass through charging.

**Q5: How to calculate the E3800 LFP running time?**

A: To estimate the operation time of the E3800 LFP, consider the load you're applying:

Operation time = Battery Capacity (Wh) x DoD x n ÷ (Load Power + E3800 LFP Self-consumption)

Note: DoD is the depth of discharge. n is the conversion efficiency of the inverter, which is typically over 93% for the E3800 LFP. The self-consumption power of the E3800 LFP is approximately 22W.

Operation time = 3840Wh x 95% x 93% ÷ (40W + 22W) ≈ 54.7 hours.

Please keep in mind that the estimated operation time provided is for reference purposes and may vary based on actual usage conditions. Factors such as low temperature and excessive loads can significantly affect the battery capacity, leading to a reduction in the average operation time.

**Q6: Can I use the E3800 LFP indoors and charge the E3800 LFP indoors?**

A: Yes, the E3800 LFP is safe to use indoors.

**Q7: Does E3800 LFP have built-in MPPT charge controller?**

A: Yes, there are two independent 1500W(PV 32V-150V) MPPT charge controllers inside, and one step up 150W(PV 12V~30V) MPPT charge controller, The Voc ( Open Circuit Voltage) of the solar panels should not exceed 150V.

## MAINTENANCE AND UPKEEP/CARE

1: Store the device in an environment between -20°C (-4°F) and 45°C (113°F).

The recommended temperature range is approximately 0°C (32°F) to 30°C (86°F) to maintain the battery's health.

2: Store the product in a dry, cool, well-ventilated, and safe area to reduce the risk of drops.

3: Keep the device away from water sources, heat sources, strong magnetic fields, corrosive gas environments, and any flammable or explosive materials.

4: Fully charge the device at least once every two months.

Prolonged partial charging may lead to inaccurate battery reading and degraded battery consistency.

5: For long-term storage, charge and discharge the product once every three months (fully charge, then discharge to 60% for storage) to maintain battery health.

6: Do not leave the device uncharged or unused for more than six months; otherwise, the warranty will be void.

7: If the power port is dirty, wipe it clean with a dry cloth. Do not use alcohol or other flammable agents to clean.

8: Do not disassemble or modify this product on your own.

## DISCLAIMER

Please read the user manual thoroughly before using this product, and keep this manual in a safe place for future reference. Failure to follow the instructions for proper set up, use, and care for the device can increase the risk of serious personal injury, death, or property damage. Once you use this device, you are deemed to have understood, recognized and accepted all terms and contents of this document. The user shall be responsible for his own actions and all consequences arising from failure to use the device in accordance with the “User Manual” , or as authorized in PECRON's current product literature. In compliance with laws and regulations, PECRON reserves all rights for final explanation, and to change these terms and conditions at any time without prior notice. In the event that any revisions are made, the revised terms and conditions shall be posted on our website immediately, please visit our website to inform yourself of any changes.

## WARNING

- 1: Do not place the device near heat source, such as a fire or a heating furnace.
- 2: Do not immerse in any liquid, or expose the unit to rain or wet conditions.
- 3: Do not use the battery in a strong static electricity or electromagnetic environment.
- 4: Do not disassemble or puncture the product with sharp objects in any way.
- 5: Short circuits can be caused by: vermin or pests chewing through wires; water or other fluids coming into contact with electrical wiring.
- 6: It's prohibited to be used as car jump starter, only can be used to charge the car battery.
- 7: Do not use accessories or parts other than those provided by PECRON. Please visit our website [www.pecron.com](http://www.pecron.com) or reach our support team for a complete list of accessories and parts.
- 8: When using this product, please strictly follow the ambient temperature for use in the user manual. If the temperature is too high, the battery can potentially result in self-combustion and will burst into flames, which can cause widespread damage. If the temperature is too low, the performance of the battery will be seriously degraded, and it may even fail to meet the normal use requirements.
- 9: Do not stack heavy objects on this product.
- 10: Do not block the air vents during use, or leave the device in a non-ventilated or dusty space.
- 11: Please avoid impacts, fall off, and violent vibration. Please turn off the device immediately and stop using it in the event of major exterior impact. Please fasten the unit firmly during transportation to avoid vibration and impact.
- 12: In the event of immersing the device into the water accidentally, please place the unit in a safe open area and keep away from the unit until it is completely dry. The dried unit should not be reused and should be disposed of properly according to the local regulation. If the device catches fire, use the fire extinguishing equipment in the following recommended order: water or mist, sand, fire blanket, dry chemical, carbon dioxide fire extinguisher.
- 13: Please wipe it with a dry cloth to clean the surface of the device.
- 14: Please place this device with care to prevent the product from being damaged due to fall off. If the product is damaged due to fall off, please turn off the unit immediately and place it in an open area, keep away from combustibles and crowds, and dispose of in accordance with local laws and regulations.
- 15: Please store this device in a place out of reach of children and pets.

## DISPOSAL

- 1: When conditions permit, please be sure to completely discharge the battery of this product, and then put the product in the designated battery recycling box. This product contains batteries. Batteries are dangerous chemicals and are strictly prohibited from being disposed of in ordinary trash. For details, please follow local laws and regulations on battery recycling and disposal.
- 2: If the battery cannot be completely discharged due to the failure of the product itself, please do not dispose of the battery directly in the battery recycling box, and contact a professional battery recycling company for further disposal.
- 3: The battery will not be able to start after being over-discharged, please dispose of it according to the principle of disposal.

## EXCLUSIONS

PECRON's warranty does not apply to:

Misused, abused, modified, damaged by accident, or used for anything other than normal consumer use as authorized in PECRON's current product literature.

## NEED HELP? WE' RE HERE FOR YOU!

WEBSITE: [www.pecron.com](http://www.pecron.com)

Customer Support: [support@pecron.com](mailto:support@pecron.com)

Call Us: +1 888 906 5997 ( 9am -5pm EST, Mon. -Fri.)

Please note your order number and platform of purchase, so we can quickly help you check the order info and solve it.  
**PECRON thank you for your support and cooperation!**



POWER IT POSSIBLE

[www.pecron.com](http://www.pecron.com)

..... [support@pecron.com](mailto:support@pecron.com) .....